

SENCO®



PalletPro™ 130



Parts Reference Guide



*** Schematic drawings inside**

*Senco Products Inc.
8485 Broadwell Road
Cincinnati, Ohio 45244
Visit Our Website: www.senco.com*

*Questions? Comments? call Senco's toll-free Action-line:
1-800-543-4596 (North and South America Only)
or e-mail: toolprof@senco.com*

NFG05M Revised July 30, 2008 (Replaces 6/26/08) © 2008 by Senco Products, Inc. Cincinnati, Ohio 45244 - U.S.A.

Tool #	Model
5M0001N	CONTACT ACTUATION
5M2001N	CONTACT ACTUATION

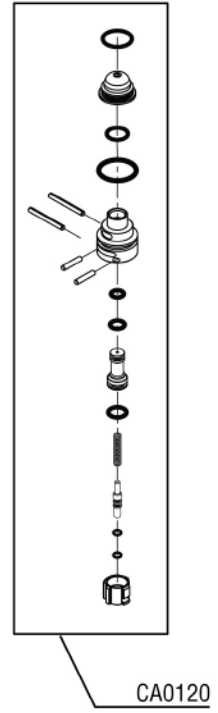
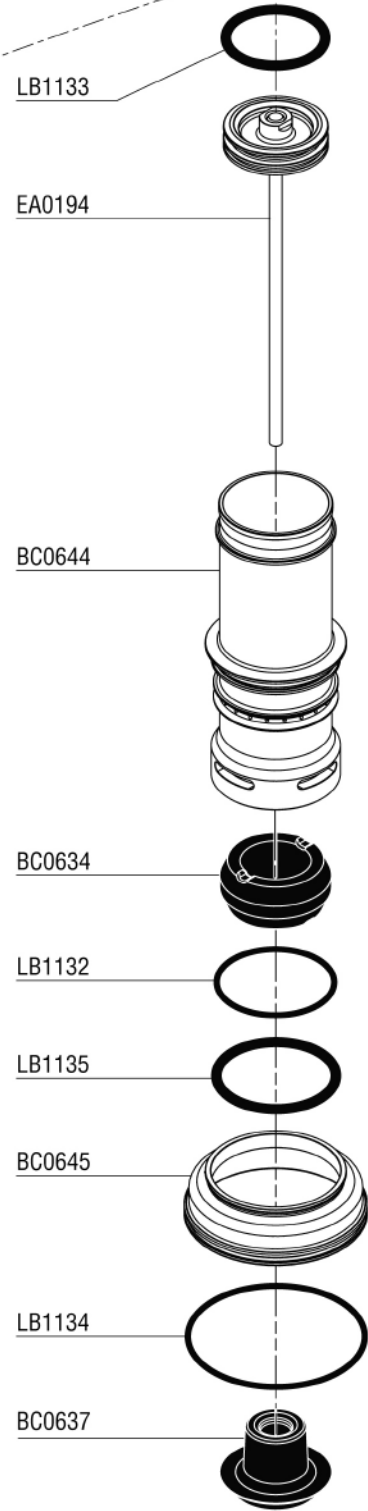
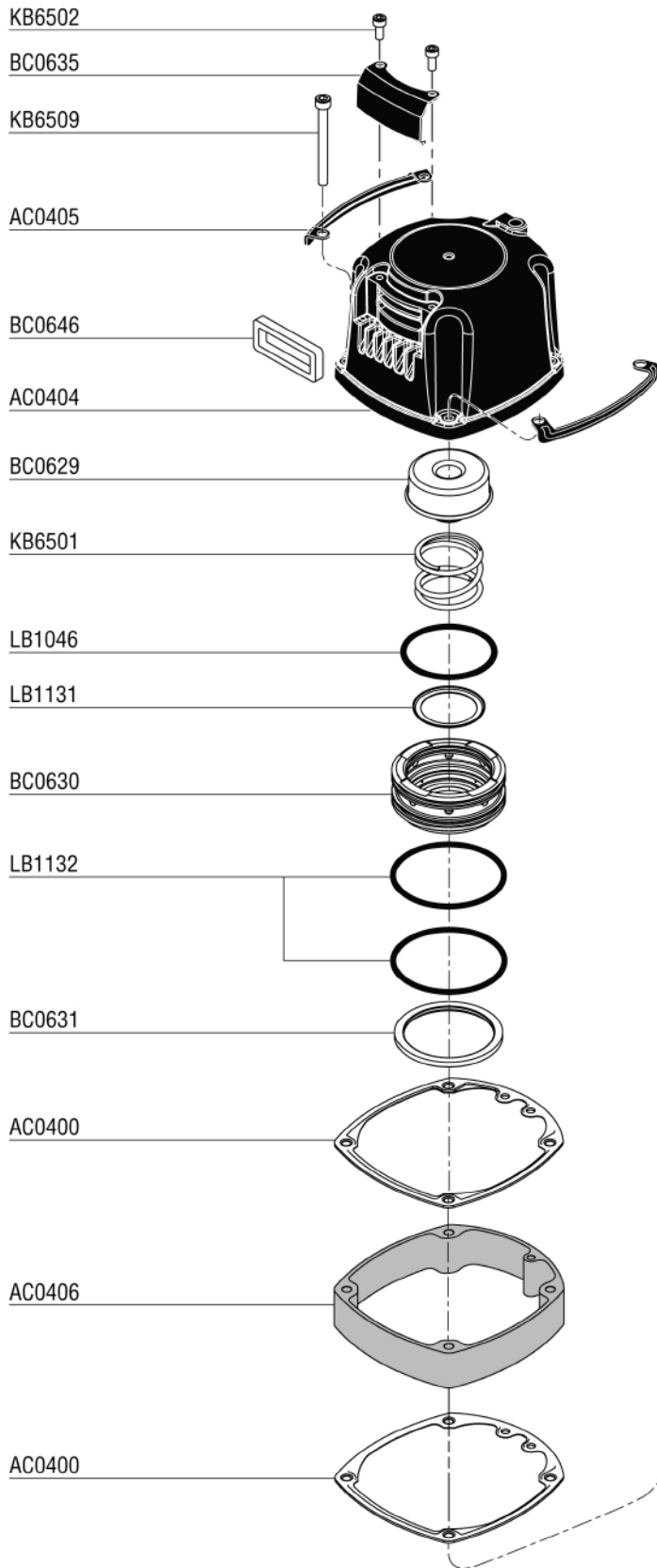

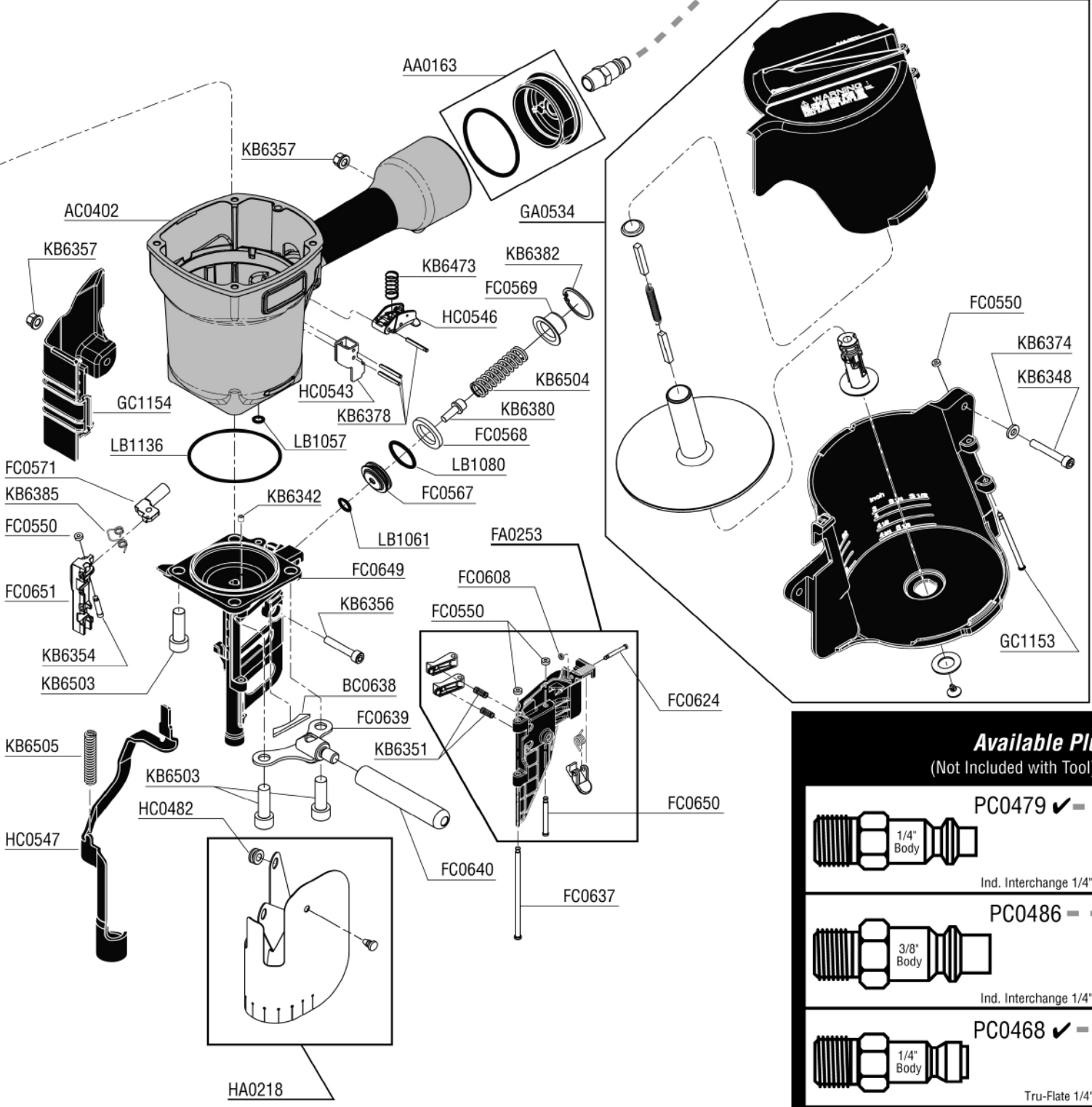

NFG05M Revised July 30, 2008 (Replaces 6/26/08) © 2008 by Senco Products, Inc. Cincinnati, Ohio 45244 - U.S.A.

Available Plugs (Not Included with Tool)

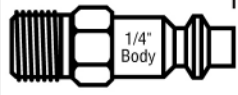
- 

PC0479 ✓

1/4" Body

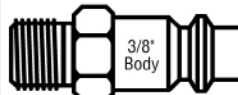
Ind. Interchange 1/4"
- 

PC0486

3/8" Body

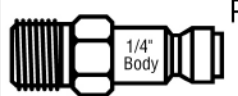
Ind. Interchange 1/4"
- 

PC0468 ✓

1/4" Body

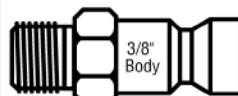
Tru-Flate 1/4"
- 

PC0474

3/8" Body

Tru-Flate 1/4" NPT

✓ **Recommended Plugs**
Plugs shown smaller than actual size

PalletPro™ 130

REPLACEMENT PARTS LIST • LISTA DE PARTES DE REPUESTO • ERSATSTEILE-LISTE • LISTE DE PIÈCES DE RECHANGE

PART NO.	DESCRIPTION	DESCRIPCIÓN	BESCHREIBUNG	DÉSIGNATION
AA0163	CAP	TAPA	KAPPE	BOUCHON
AC0400	SEAL, CYLINDER CAP	SELLO	DICHTUNG	JOINT
AC0402	MAIN BODY	CARCASA	GEHÄUSE	CORPS
AC0404	CAP	TAPA	KAPPE	BOUCHON
AC0405	COVER	PLACA	SCHUTZPLATTE	BOUCLIER ANTIABRASIF
AC0406	SPACER	SEPARADOR	DISTANZSTÜCK	ENRETOISE
BC0629	SEAL	SELLO	DICHTUNG	JOINT
BC0630	VALVE	VÁLVULA	VENTIL	VALVE
BC0631	CYLINDER COLLAR	CILINDRO	ZYLINDER	CYLINDRE
BC0634	STOP, PISTON	TOPPE	PUFFER	ARRÊT
BC0635	DEFLECTOR	DESVIADOR	ABWEISER	DÉFLECTEUR
BC0637	STOP, PISTON	TOPPE	PUFFER	ARRÊT
BC0638	SEAL	SELLO	DICHTUNG	JOINT
BC0644	CYLINDER	CILINDRO	ZYLINDER	CYLINDRE
BC0645	SPACER, CYLINDER	SEPARADOR	DISTANZSTÜCK	ENRETOISE
BC0646	MUFFLER	SILENCIADOR	DÄMPFER	SILENCIEUX
CA0120	VALVE ASSEMBLY	ASAMBLE DE VALVULA	VENTIL-ZUSAMMENBAU	VALVE D'ASSEMBLÉE
EA0194	DRIVER ASSY	PERCUSOR	TREIBER	COUTEAU
FA0253	DOOR	PUERTA	ABDECKSCHIEBER	PORTE
FC0550	RETAINER	JUNTA TÓRICA	SICHERUNGSRING	RETENUE
FC0567	PISTON, FEED	PISTON	KOLBEN	PISTON
FC0568	STOP	TOPPE	PUFFER	ARRÊT
FC0569	CAP	TAPA	KAPPE	BOUCHON
FC0571	PISTON, FEED	PISTON	KOLBEN	PISTON
FC0608	RETAINER	JUNTA TÓRICA	SICHERUNGSRING	RETENUE
FC0624	PIN	PASADOR	STIFT	GOUPILLE
FC0637	PIN	PASADOR	STIFT	GOUPILLE
FC0639	PLATE	PLACA	PLATTE	PLAQUE
FC0640	HANDLE	MANIJA	HANDGRIFF	POIGNÉE
FC0649	GUIDE BODY	PLACA DE NARIZ	NAGELFÜHRUNG	FRONT
FC0650	PIN	PASADOR	STIFT	GOUPILLE
FC0651	FEED PAWL	ALIMENTADOR	VORSCHIEBER	POUSSOIR
GA0534	MAGAZINE ASY	CARGADOR	MAGAZIN	MAGASIN
GC1153	PIN	PASADOR	STIFT	GOUPILLE
GC1154	COVER	CUBIERTA	ABDECKUNG	COUVERCLE
HA0218	COVER	CUBIERTA	ABDECKUNG	COUVERCLE
HC0482	RING	ANILLO	REIFEN	ANNEAU
HC0543	SAFETY ELEMENT	SEGURO	SICHERHEITSVORRICHTUNG	PALPEUR DE SÉCURITÉ
HC0546	TRIGGER	GATILLO	AUSLÖSER	GÂCHETTE
HC0547	SAFETY ELEMENT	SEGURO	SICHERHEITSVORRICHTUNG	PALPEUR DE SÉCURITÉ
KB6342	SCREW	TORNILLO	SCHRAUBE	VIS
KB6348	SCREW	TORNILLO	SCHRAUBE	VIS
KB6351	SPRING	RESORTE	FEDER	RESSORT
KB6354	PIN	PASADOR	STIFT	GOUPILLE
KB6356	SCREW	TORNILLO	SCHRAUBE	VIS
KB6357	NUT	TUERCA	MUTTE	ÉCROU
KB6374	WASHER	ARANDELA	SCHEIBE	RONDELLE
KB6378	PIN	PASADOR	STIFT	GOUPILLE
KB6380	SCREW	TORNILLO	SCHRAUBE	VIS
KB6382	RING	ANILLO	REIFEN	ANNEAU
KB6385	SPRING	RESORTE	FEDER	RESSORT
KB6473	SPRING	RESORTE	FEDER	RESSORT
KB6501	SPRING	RESORTE	FEDER	RESSORT
KB6502	SCREW	TORNILLO	SCHRAUBE	VIS
KB6503	SCREW	TORNILLO	SCHRAUBE	VIS
KB6504	SPRING	RESORTE	FEDER	RESSORT
KB6505	SPRING	RESORTE	FEDER	RESSORT
KB6509	SCREW	TORNILLO	SCHRAUBE	VIS
LB1046	SEAL	SELLO	DICHTUNG	JOINT
LB1057	SEAL	SELLO	DICHTUNG	JOINT
LB1061	SEAL	SELLO	DICHTUNG	JOINT
LB1080	SEAL	SELLO	DICHTUNG	JOINT
LB1131	SEAL	SELLO	DICHTUNG	JOINT
LB1132	SEAL	SELLO	DICHTUNG	JOINT
LB1133	SEAL	SELLO	DICHTUNG	JOINT
LB1134	SEAL	SELLO	DICHTUNG	JOINT
LB1135	SEAL	SELLO	DICHTUNG	JOINT
LB1136	SEAL	SELLO	DICHTUNG	JOINT